

4

3

2

1

B

B

A

A

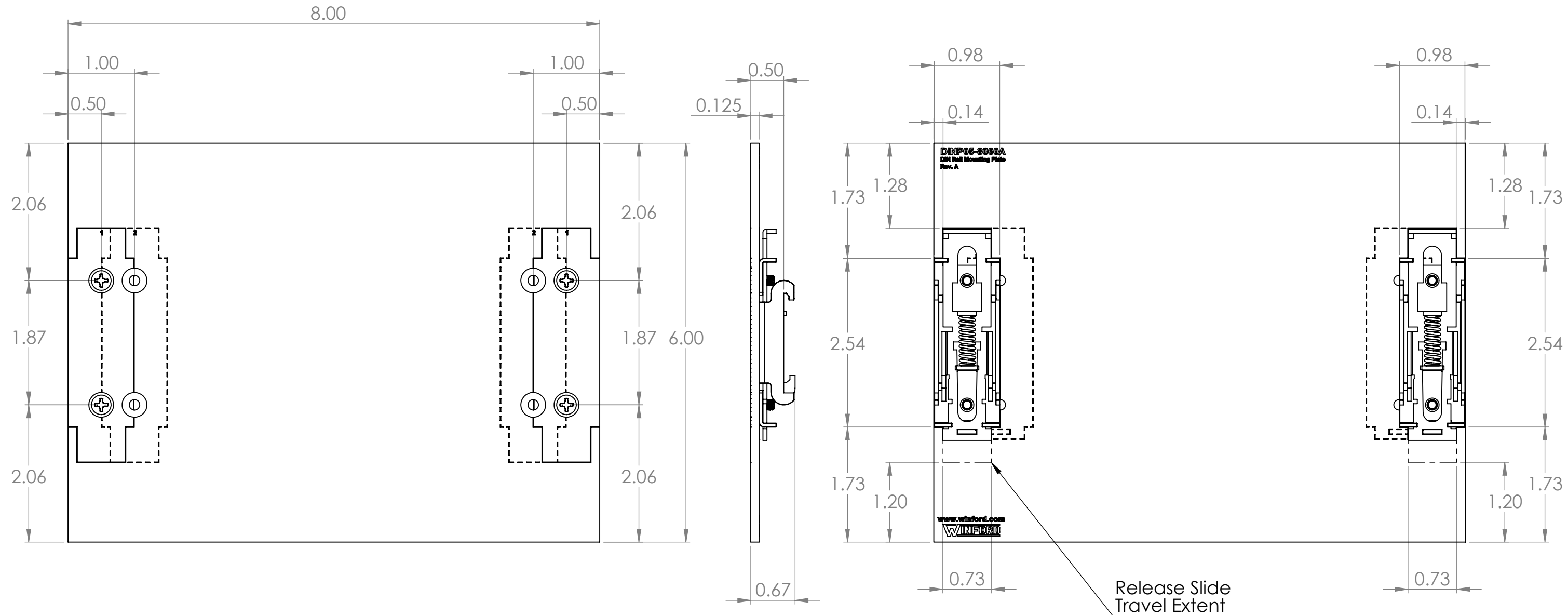

DIM: INCH	DATE: 05/17/2021	RoHS COMPLIANT: Yes	DESCRIPTION:
 WINFORD ENGINEERING, LLC 4561 GARFIELD ROAD AUBURN, MI 48611			DIN Rail Mounting Plate 8" x 6"
www.winford.com		989-671-9721	PART NUMBER (S)
			DINP05-8060A-1
			PART REVISION
			A

4

3

2

1