

4

3

2

1

B

B

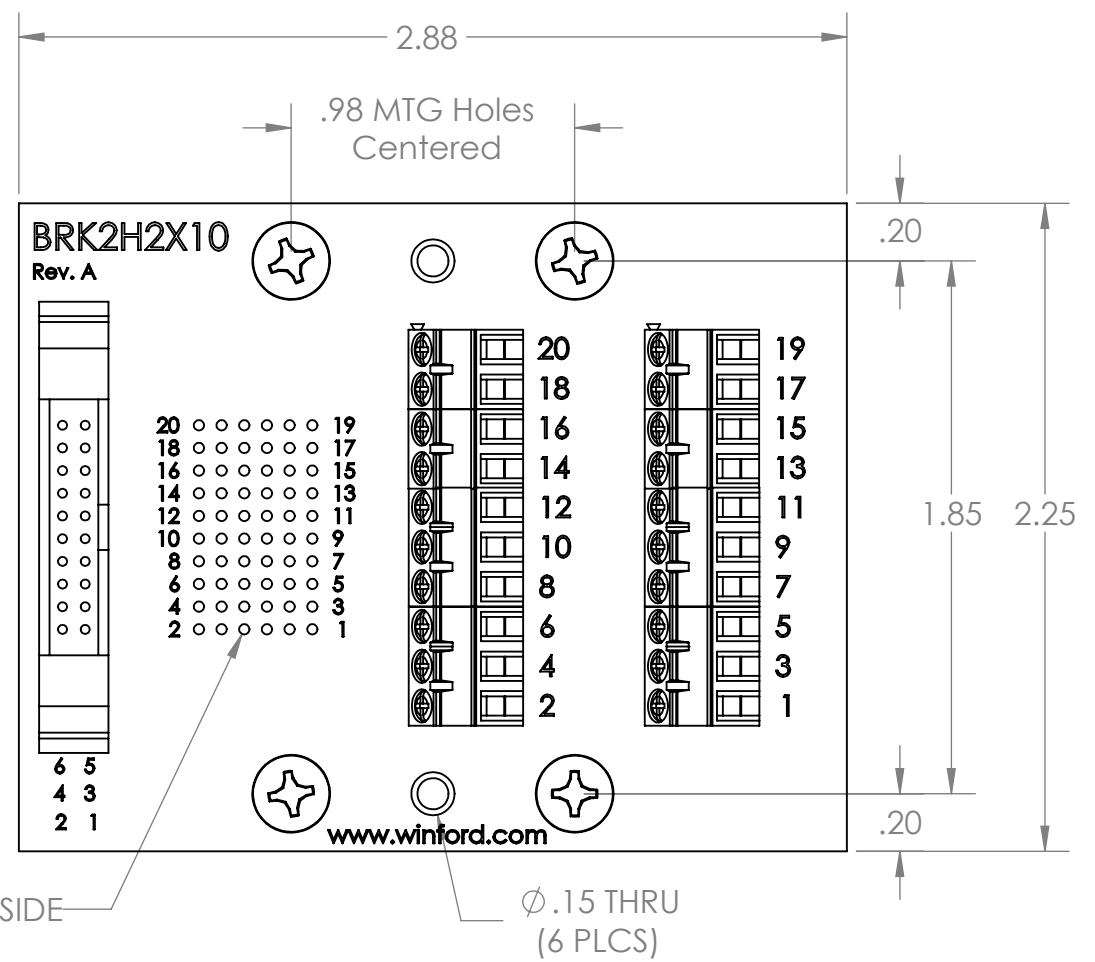
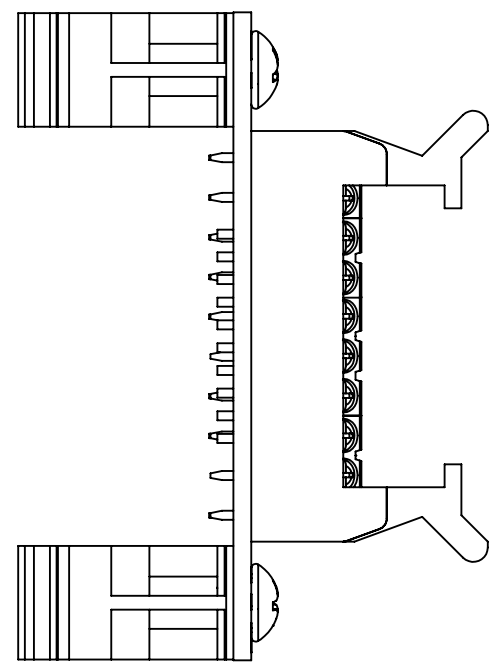



Ø.04 INSIDE

Ø.15 THRU (6 PLCS)

A

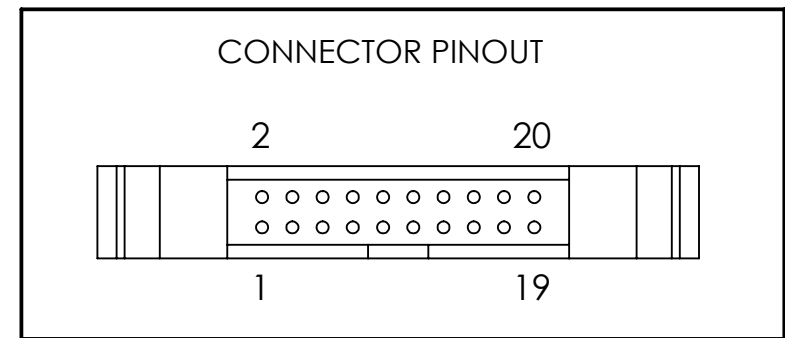
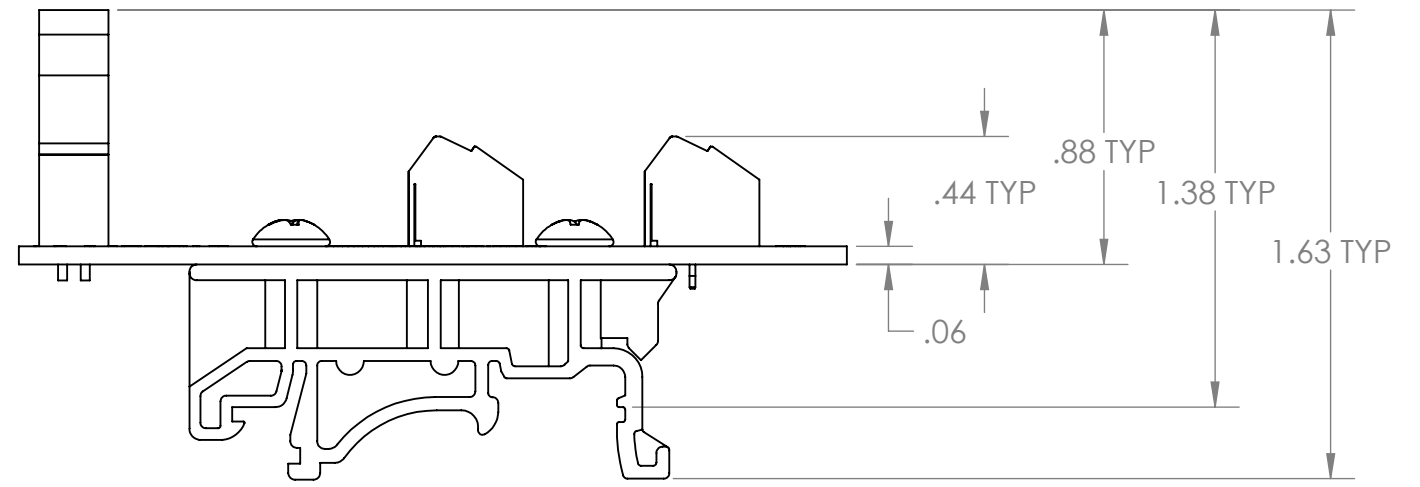
A



DIM: INCH	DATE: 08/19/2022	RoHS COMPLIANT: YES	DESCRIPTION:
 WINFORD ENGINEERING, LLC 4561 GARFIELD ROAD AUBURN, MI 48611			2x10 2mm Header Breakout
www.winford.com		989-671-9721	PART NUMBER (S) BRK2H2X10-L-DIN
			PART REVISION A

4

3

2

1